

SPIRIT™



Z8

Motorized Treadmill

OWNER'S MANUAL

**PLEASE CAREFULLY READ THIS ENTIRE MANUAL BEFORE
OPERATING YOUR NEW TREADMILL!**

Table of Contents

Product Registration.....	2
Important Safety Instructions.....	3
Important Electrical Information.....	4
Important Operation Instructions.....	5
Assembly instructions.....	6
Folding Instructions.....	8
Operation of Your New Treadmill.....	9
Programmable Features.....	11
Target Heart Rate.....	15
Maintenance of Your New Treadmill.....	16
Service Checklist - Diagnosis Guide.....	18
Manufacturer's Limited Warranty.....	19

ATTENTION-THIS TREADMILL IS INTENDED FOR RESIDENTIAL USE ONLY AND IS WARRANTED FOR THAT APPLICATION. ANY OTHER APPLICATION VOIDS THIS WARRANTY IN ITS ENTIRETY.



**CONGRATULATIONS ON YOUR
NEW TREADMILL AND WELCOME
TO THE SPIRIT FAMILY!**

Thank you for your purchase of this quality treadmill from Spirit Manufacturing, Inc. Your new treadmill was manufactured by one of the leading fitness manufacturers in the world and is backed by one of the most comprehensive warranties available. Through your dealer, Spirit will do all we can to make your ownership experience as pleasant as possible for many years to come. The local dealership where you purchased this treadmill is your administrator for all Spirit warranty and service needs. Their responsibility is to provide you with the technical knowledge and service personnel to make your experience more informed and any difficulties easier to remedy.

Please take a moment at this time to record the name of the dealer, their telephone number, and the date of purchase below to make any future, needed contact easy. We appreciate your support and we will always remember that you are the reason that we are in business. Please complete and mail your registration card today and enjoy your new treadmill.

Yours in Health,
Spirit Manufacturing, Inc.

Name of Dealer _____
Telephone Number of Dealer _____
Purchase Date _____

Product Registration

RECORD YOUR SERIAL NUMBER

Please record the Serial Number of this fitness product in the space provided below.

Serial Number _____

REGISTER YOUR PURCHASE

The self-addressed product registration card must be completed in full and returned to Spirit Manufacturing, Inc or visit www.spiritfitness.com to register online.

Important Safety Instructions

WARNING - Read all instructions before using this appliance.

DANGER - To reduce the risk of electric shock disconnect your Spirit treadmill from the electrical outlet prior to cleaning and/or service work.

WARNING - To reduce the risk of burns, fire, electric shock, or injury to persons, install the treadmill on a flat level surface with access to a 120-volt, 20-amp grounded outlet.

DO NOT USE AN EXTENSION CORD: DO NOT ATTEMPT TO DISABLE THE GROUNDED PLUG BY USING IMPROPER ADAPTERS, OR IN ANY WAY MODIFY THE CORD SET. A serious shock or fire hazard may result along with computer malfunctions. See Grounding Instructions, page 4.

- Do not operate treadmill on deeply padded, plush or shag carpet. Damage to both carpet and treadmill may result.
- Do not block the rear of the treadmill. Provide a minimum of 3 1/2 feet clearance between the rear of the treadmill and any fixed object.
- Keep children away from the treadmill. There are obvious pinch points and other caution areas that can cause harm.
- Keep hands away from all moving parts.
- Never operate the treadmill if it has a damaged cord or plug. If the treadmill is not working properly, call your dealer.
- Keep the cord away from heated surfaces.
- Do not operate where aerosol spray products are being used or where oxygen is being administered. Sparks from the motor may ignite a highly gaseous environment.
- Never drop or insert any object into any openings.
- Do not use outdoors.
- To disconnect, turn all controls to the off position, remove tether cord, then remove the plug from the outlet.
- Do not attempt to use your treadmill for any purpose other than for the purpose it is intended.
- The pulse sensors are not medical devices. Various factors, including the user's movement, may affect the accuracy of heart rate readings. The pulse sensors are intended only as exercise aids in determining heart rate trends in general.
- Use handrails provided; they are for your safety.
- Wear proper shoes. High heels, dress shoes, sandals or bare feet are not suitable for use on your treadmill. Quality athletic shoes are recommended to avoid leg fatigue.

Remove tether cord after use to prevent unauthorized treadmill operation.

SAVE THESE INSTRUCTIONS - THINK SAFETY!

Important Electrical Information

WARNING!

- **NEVER** use a ground fault circuit interrupt (GFCI) wall outlet with this treadmill. Route the power cord away from any moving part of the treadmill including the elevation mechanism and transport wheels.
- **NEVER** remove any cover without first disconnecting AC power.
- If voltage varies by ten percent (10%) or more, the performance of your treadmill may be affected. **Such conditions are not covered under your warranty.** If you suspect the voltage is low, contact your local power company or a licensed electrician for proper testing. See Diagnosis Guide, page 20.
- **NEVER** expose this treadmill to rain or moisture. This product is **NOT** designed for use outdoors, near a pool or spa, or in any other high humidity environment.

Grounding Instructions

This product must be grounded. If the treadmill should malfunction or breakdown, grounding provides a path of least resistance for electric current, reducing the risk of electric shock. This product is equipped with a cord having an equipment-grounding plug. The plug must be plugged into an appropriate outlet that is properly installed and grounded in accordance with all local codes and ordinances.

DANGER - Improper connection of the equipment-grounding conductor can result in a risk of electric shock. Check with a qualified electrician or serviceman if you are in doubt as to whether the product is properly grounded. Do not modify the plug provided with the product if it will not fit the outlet, have a proper outlet installed by a qualified electrician.

This product is for use on a nominal 120-volt circuit, and has a grounding plug that looks like the plug illustrated below. A temporary adapter that looks like the adapter illustrated below may be used to connect this plug to a 2-pole receptacle as shown below if a properly grounded outlet is not available. The temporary adapter should be used only until a properly grounded outlet (below) can be installed by a qualified electrician. The green colored rigid ear-lug, or the like, extending from the adapter, must be connected to a permanent ground such as a properly grounded outlet box cover. Whenever the adapter is used, it must be held in place by a metal screw.

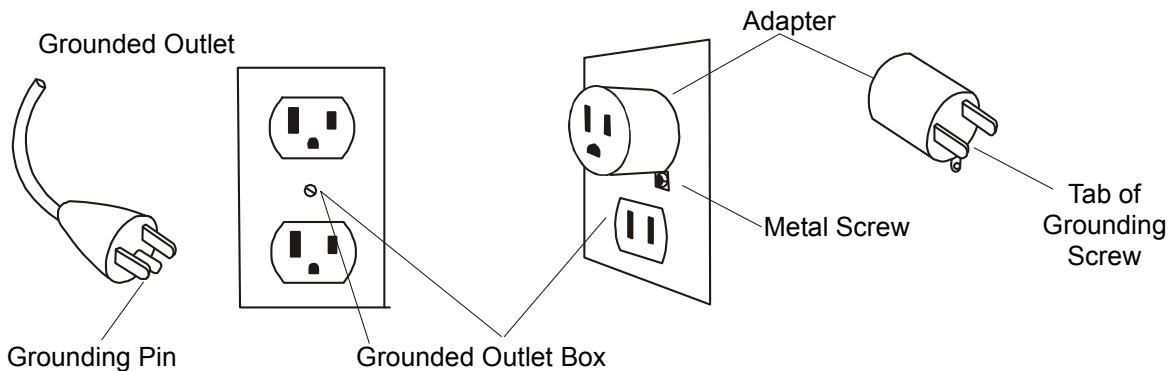

Important Operation Instructions

- **NEVER** operate this treadmill without reading and completely understanding the results of any operational change you request from the computer.
- Understand that changes in speed and incline do not occur immediately. Set your desired speed on the computer console and release the adjustment key. The computer will obey the command gradually.
- **NEVER** use your treadmill during an electrical storm. Surges may occur in your household power supply that could damage treadmill components.
- Use caution while participating in other activities while walking on your treadmill; such as watching television, reading, etc. These distractions may cause you to lose balance or stray from walking in the center of the belt; which may result in serious injury.
- **NEVER** mount or dismount the treadmill while the belt is moving. Spirit treadmills start at a very low speed and it is unnecessary to straddle the belt during start up. Simply standing on the belt during slow acceleration is proper after you have learned to operate the unit.
- Always hold on to a handrail or hand bar while making control changes (incline, speed, etc.).

Do not use excessive pressure on console control keys. They are precision set to function properly with little finger pressure. Pushing harder is not going to make the unit go faster or slower. If you feel the buttons are not functioning properly with normal pressure contact your Spirit dealer.

Safety Tether Cord

A safety tether cord is provided with this unit. It is a simple magnetic design that should be used at all times. It is for your safety should you fall or move too far back on the tread-belt.

Pulling this safety tether cord will stop tread-belt movement.

To Use:

1. Place the magnet into position on the round metal portion of the console control head. Your treadmill will not start and operate without this. Removing the magnet also secures the treadmill from unauthorized use.

2. Fasten the plastic clip onto your clothing securely to assure good holding power.

Note: The magnet has strong enough power to minimize accidental, unexpected stopping. The clip should be attached securely to make certain it does not come off. Be familiar with its function and limitations. The treadmill will stop, depending on speed, with a one to two step coast anytime the magnet is pulled off the console. Use the red Stop / Pause switch in normal operation.

Assembly Instructions (Z8)

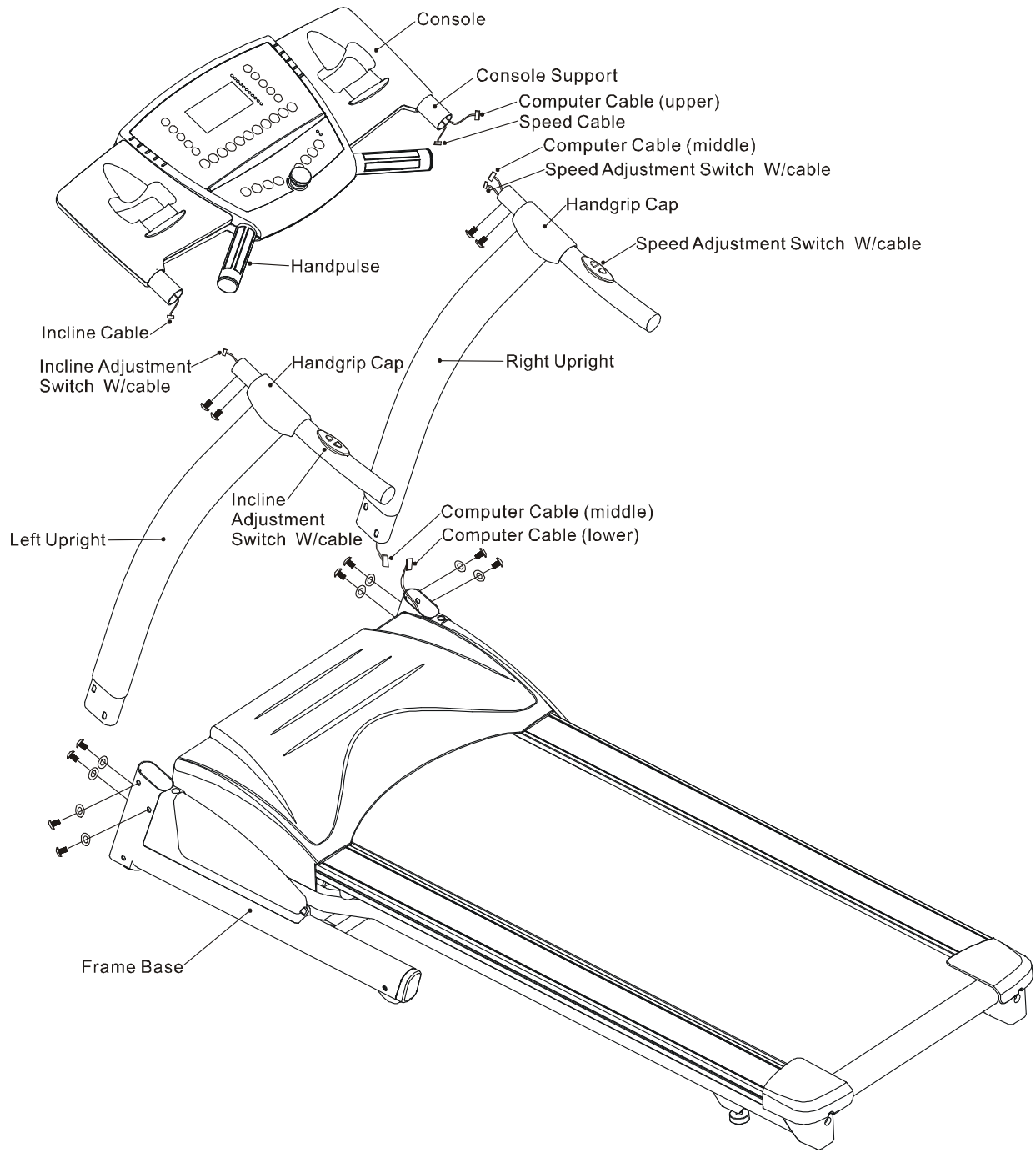

ASSEMBLY PACK CHECK LIST (Z8)

5/16"x18x1.5T Flat Washer (x4)
5/16"x23x1.5T Curve Washer (x4)
5/16"x1/2"Button Head Socket Screw (x12)
Safety Key (x1)
Lubricant (x1)
M5 Allen Wrench (x1)
M6 Allen Wrench (x1)

Assembly (Z8)

■ STEP 1

Remove all parts from the carton.

■ STEP 2

Connect Computer Cable (Lower) with Computer Cable (Middle).

■ STEP 3

Hand tighten the Right and Left Handrails into the Frame Base with 8 pcs of 5/16" x 1/2" Button Head Socket Screws, 4 pcs of 5/16" x 18 x 1.5T Flat Washers and 4 pcs of 5/16"x 23 x 1.5T Curve Washers by using the M5 Allen Wrench.

■ STEP 4

Connect Computer Cable (Middle) with Computer cable (Upper).

Connect Speed Adjustment Switch w/Cable with Speed Cable (Upper).

And connect Incline Adjustment Switch w/Cable with Incline Cable (Upper).

■ STEP 5

Install the Console Support into the Right and Left Handrails with 4 pcs of 5/16" x 1/2" Button Head Socket Screws by using M5 Allen Wrench.

■ PLEASE LOCK DOWN ALL HARDWARE AFTER THE ACCESSORIES HAVE BEEN ASSEMBLED.

Z8 Folding Instructions

Do not attempt to move the unit unless it is in the folded and locked position. Be sure the power cord is secured to avoid possible damage. Use both handrails to maneuver the unit to the desired position.

■ To Fold The Treadmill:

Ensure the incline angle of the treadmill is at its lowest position. Lift the treadmill running board up until locking knob install into the hole.

■ To Unfold The Treadmill:

Hold the treadmill running board with left hand. Pull the locking knob with your right hand and slowly lower the treadmill running board. *Remove your right hand as you slowly lower the running board to the floor.

Transport

■ Z8

The treadmill is equipped with four transport wheels which are engaged when the treadmill is folded. After folding simply roll the treadmill away.

Operation of Your Treadmill

Getting familiar with the control panel

■ Z8 Console



INITIAL DISPLAY:

ODO: Displays total accumulated working distance in DISTANCE window from 0.00 to 999 miles.

HRS: Displays total accumulated working time in TIME window from 0 to 99:99. If exceed 99:99 minutes window will display by hour from 1 to 9999.

VER: Displays current software version in SPEED window.

WINDOW DISPLAY:

DISTANCE: Accumulates total workout distance from 0.00 to 99.99 miles.

TIME: Accumulates total workout time from 00:00 to 99:59.

CALORIES: Accumulates the user's calorie consumption during exercise. Max. Value is 999.9 calories.

SPEED: Displays the current running speed from 0.5Mph- 10Mph.

PULSE: Displays your current heart rate in beats per minute during workout. If computer doesn't receive heart rate input, dot will not flash on the side of P.

INCLINE: Displays your current workout elevation from 0 to 10.

LAPS/PROGRAM: Accumulates total Laps from L00 to L99 and displays your current workout program you can press "MODE" button to exchange display window.

LUBE: Reminds user to apply silicon lubricant between the belt and deck. If "ODO" or "HRS" achieve target where "HRS" is 180 hours and "ODO" is 600 miles window will display "LUBRICATE DECK". If reminded a third time, it will display "PRESS MODE 3 SECONDS TO CANCEL THIS MESSAGE".

FUNCTION BUTTONS:

START: Press "START" button to start training.

STOP: Press "STOP" button to stop training and press for 3 seconds to clear all screen data.

FAST: Press "FAST" button to increase your speed.

SLOW: Press "SLOW" button to decrease your speed.

UP: Press "UP" button to increase elevation position.

DOWN: Press "DOWN" button to decrease elevation position.

MODE: Press "MODE" button to select different setting mode in STOP or PROGRAM mode.

SELECT: Press "SELECT" button to choose type of profile display. Before running, you can display either speed or incline or display two profiles at same time in PROGRAM mode.

PROGRAM: Press program buttons to choose training mode.

SAFETY KEY: Put safety key in position to power on the computer. When safety key is pulled away from its position, the computer will automatically shut down.

QUICK SPEED KEYS:

5 preset buttons for rapid speed: 2Mph, 4Mph, 6Mph, 8Mph, 10Mph. User can press the 5 buttons, mentioned above, at any time, to start treadmill and treadmill will automatically adjust to preset speed.

QUICK INCLINE KEYS:

5 preset buttons for rapid incline: 2, 4, 6, 8, 10. User can press the 5 buttons, mentioned above, at any time, to start treadmill and treadmill will automatically adjust to preset elevation.

CONSOLE OPERATION:

1. Put the safety key in position and all data will be displayed then the major screen will show ODO, HRS, VER. User can press any buttons to enter next step. When treadmill has started, above values will accumulate. Pressing "STOP" button will end exercise session.
2. Press any pre-set program you like then press "START" button to begin the program.
3. While exercising, you can press FAST/SLOW button to adjust the speed manually.
4. While exercising, you can press "STOP" button to stop your workout or pull safety key away from its position to shut down the computer.
5. If after pressing "STOP" button to stop the treadmill, and you want to resume your workout, you can press "START" button again to start the treadmill then all previous data will resume counting.

Programmable Features

MANUAL

Step 1. Press "MANUAL" button and press "START" button to start running.

Step 2. Before running, press "MODE" button to set the count down time. Range is from 10:00 to 99:00, set the count down distance; range is from 0.10 to 99.90 or set the count down calories; range is from 1.0 to 999.0. Whenever any program counts down to zero the treadmill will stop. Press "START" button to restart training then treadmill will restart and target will count down, other data will count up. If you do not set count down, console will count up from zero.

Step 3. During running, user can adjust the speed by pressing "FAST/SLOW" or press rapid keys to adjust SPEED manually.

Step 4. Press "STOP" button to stop your workout or pull safety key away from its position to shut down the computer.

P1 ~ P5 (PRESET PROGRAM)

- Step 1.** Press any button to choose P1 ~ P5 in “STOP” mode, each program has a preset speed and incline value.
- Step 2.** Press “MODE” button to set the count down time from 10:00 to 99:00. User can adjust by pressing “FAST/SLOW”. If you do not set the count down, console will count up from zero. Or press “START” button immediately to start training. Time is limited to 20 minutes wherein total segments are 20 and each segment exercising time is 1 minute. Press “MODE” button again to set MAX. speed of profile from 5.0Mph to 8.0Mph.
- Step 3.** After setting, press “START” button to start training, treadmill will start a 3 minutes warm up. Or you can press “START” button again to enter exercising immediately. Treadmill will adjust the SPEED in accordance with profile. You can press “STOP” button to stop training during operation. Only Speed goes to zero, other data will save original data. If you don’t clear, press “START” button to save last time values.
*After running you can exchange speed and incline profile, press “UP/DOWN” to change to INCLINE profile and press “FAST /SLOW” to change to SPEED profile.
- Step 4.** When time counts down to zero, treadmill will be 3 minute cool down. Or press “STOP” button to stop training immediately and a series of beeps will indicate end of program.

USER 1 ~ USER 3

- Step 1.** Choose User 1 ~ User 3.
- Step 2.** Press “MODE” button to set time. You can adjust by pressing “FAST/SLOW”.
- Step 3.** Press “MODE” button again to set speed, first segment will flash and press “FAST/SLOW” button to adjust speed, press “UP/DOWN” button to enter incline programming then press “UP/DOWN” again to adjust. Press “MODE” button to enter next segment.
- Step 4.** After setting, press “START” button to start training, treadmill will adjust the SPEED and INCLINE in accordance with profile. User can press “STOP” button to stop training during operation and window will save last values. If last time is COUNT UP, press “START” to continue COUNT UP and other data will COUNT DOWN.

H.R.C. (H1 ~ H2)

Step 1. Choose H1 or H2.

Step 2. Press “MODE” button to set time. The range is from 10:00 to 99:00 and press “FAST/SLOW” to adjust. If you do not set the count down, console will count up from zero.

Step 3. Press “MODE” button again to set “AGE” in PULSE window. The range is from 10 to 99 and preset value is 30. Press “FAST/SLOW” button to adjust then window will calculate the T.H.R as below formula:

$$H1 = (220 - \text{age}) * 60\% = \text{TARGET HEART RATE}$$

$$H2 = (220 - \text{age}) * 80\% = \text{TARGET HEART RATE}$$

Step 4. After calculating, if you want to change T.H.R, press “MODE” button to enter setting “T.H.R” in PULSE window the range is from 60 to 220. Press “FAST/SLOW” button to adjust.

Step 5. If setting is finished, press START and place both hands on the handpulse grips to start your workout.

Step 6. If your heart rate doesn't achieve set value (T.H.R), the treadmill will increase INCLINE height automatically until user achieves target value. Then treadmill will adjust incline UP/DOWN to maintain your T.H.R..

ERROR MESSAGE:

1. LS: Treadmill doesn't receive the speed signal for 8 seconds.
2. E2: Incline position error.
3. Err: Memory of console malfunction or CPU accessing problem.

* SPEED PROFILE

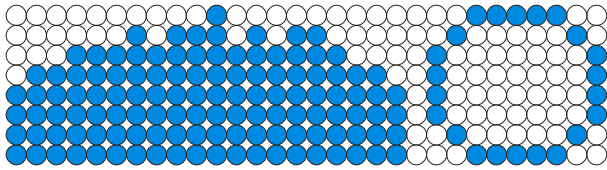

P1 SPEED PROFILE

* INCLINE PROFILE

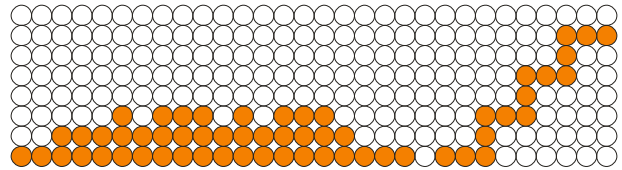

P1 INCLINE PROFILE

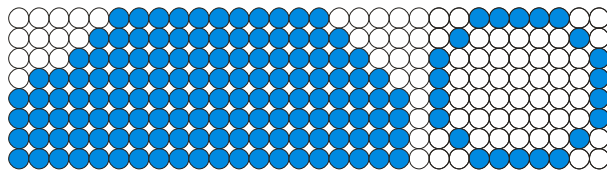

P2 SPEED PROFILE

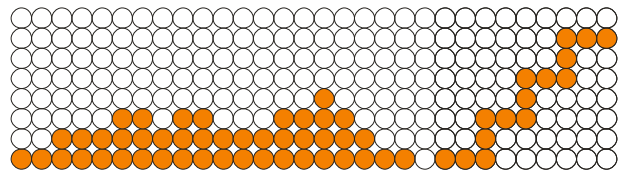

P2 INCLINE PROFILE

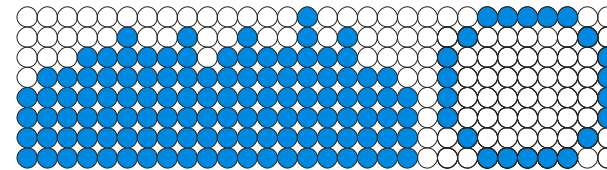

P3 SPEED PROFILE

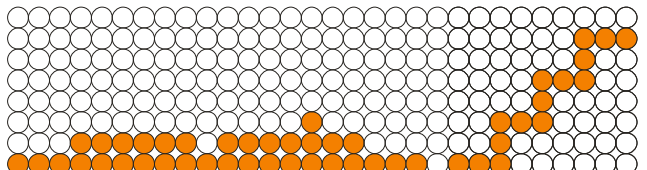

P3 INCLINE PROFILE

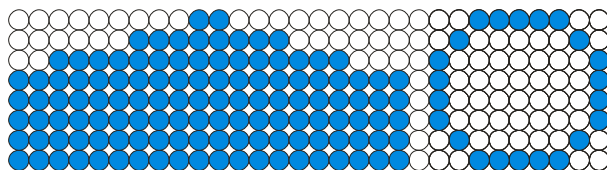

P4 SPEED PROFILE

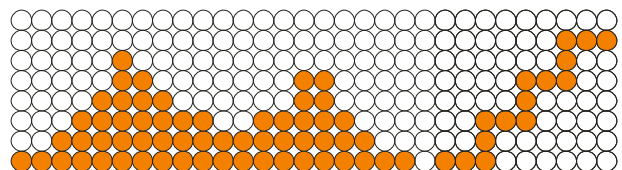

P4 INCLINE PROFILE

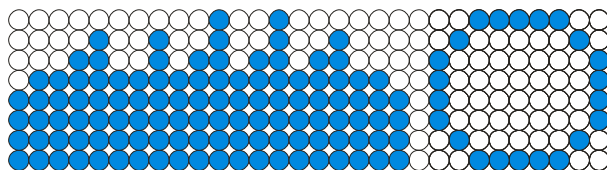

P5 SPEED PROFILE

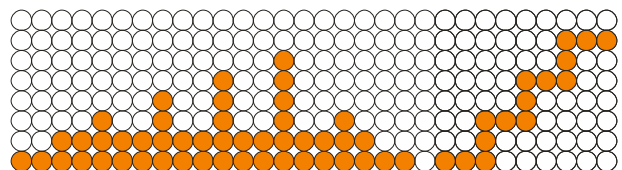

P5 INCLINE PROFILE

Target Heart Rate

● The old motto, “no pain, no gain”, is a myth that has been overpowered by the benefits of exercising comfortably. A great deal of this success has been promoted by the use of heart rate monitors. With the proper use of a heart rate monitor, many people find that their choice of exercise intensity is either too high or too low and exercise is much more enjoyable by maintaining their heart rate in the desired benefit range.

● To determine the benefit range in which you wish to train, you must first determine your Maximum Heart Rate.

This can be accomplished by using the following formula: $220 - \text{User's Age} = \text{Maximum Heart Rate}$. If you enter your age during programming of the console the console will perform this calculation automatically. This is used for the HR control programs and also for the Heart rate bar graph (Z500/Z700 only). After calculating your Maximum Heart Rate, you can decide upon which goal you would like to pursue. The two most popular reasons for, or goals of exercise, are cardiovascular fitness (training for the heart and lungs) and weight control.

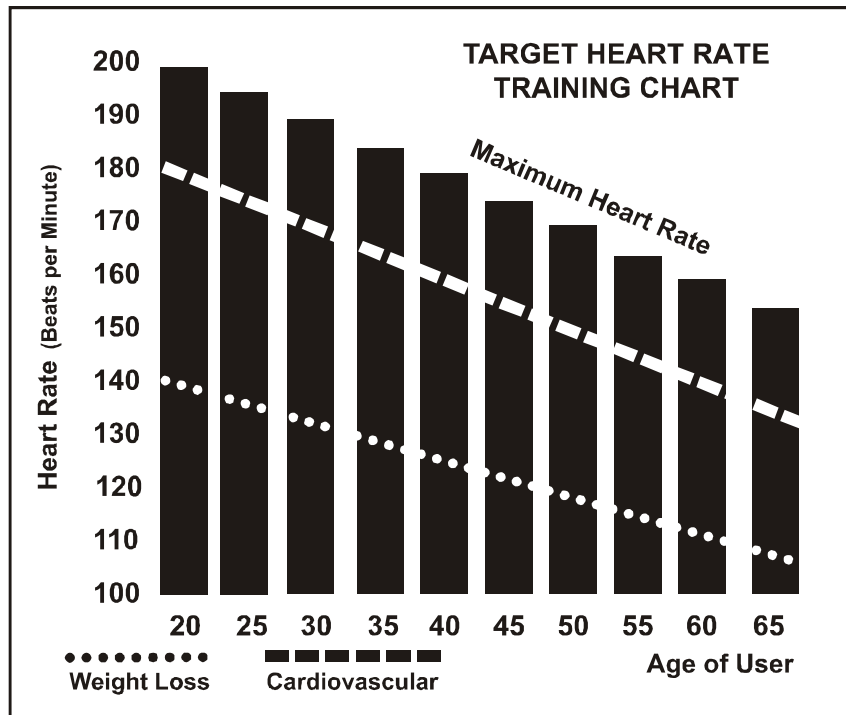

The black columns on the chart above represent the Maximum Heart Rate for a person whose age is listed at the bottom of each column. The training heart rate, for either cardiovascular fitness or weight loss, is represented by two different lines that cut diagonally through the chart. A definition of the lines' goal is in the bottom left-hand corner of the chart. If your goal is cardiovascular fitness or if it is weight loss, it can be achieved by training at 90% or 70%, respectively, of your Maximum Heart Rate on a schedule approved by your physician. Consult your physician before participating in any exercise program.

With all Spirit Heart Rate Control treadmills, you may use the heart rate monitor feature without using the Heart Rate Control program. This function can be used during manual mode or during any of the nine different programs. The Heart Rate Control program automatically controls incline.

CAUTION!

The target value used in H-1 and H-2 programs is a suggestion only for normal, healthy individuals. Do not exceed your limits! You may not be able to obtain your chosen target. If in question, enter a higher age value that will set a lower target goal.

General Maintenance

Belt and Bed - Your treadmill uses a very high-efficient low-friction bed. Performance is maximized when the bed is kept as clean as possible. Use a soft, damp cloth or paper towel to wipe the edge of the belt and the area between the belt edge and frame. Also reach as far as practical directly under the belt edge. This should be done once a month to extend belt and bed life. Use water only - no cleaners or abrasives. A mild soap and water solution along with a nylon scrub brush will clean the top of the textured belt.

Allow to dry before using.

Belt Dust - This occurs during normal break-in or until the belt stabilizes. Wiping excess off with a damp cloth will minimize buildup.

General Cleaning - Dirt, dust, and pet hair can block air inlets and accumulate on the running belt. On a monthly basis, vacuum underneath your treadmill to prevent buildup. Once a year, you should remove the black motor hood and vacuum out dirt that may accumulate. UNPLUG POWER CORD BEFORE THIS TASK.

BELT ADJUSTMENTS:



During use, if you notice that walking belt either shifts to the right or the left of center, first remove "Safety Key" and unplug equipment from AC power source. Using the M6 Allen wrench provided, turn left rear roller adjustment clockwise no more the 1/4" of a turn as indicated above. Remove the M6 Allen wrench, insert "Safety Key" and insert AC power cord into AC outlet. Turn on your treadmill and observe after running a few minutes to see if problem has been corrected. This may take several adjustments, so repeat the above procedure.

BELT / DECK LUBRICATION:

Do not re-lube with other than Spirit lubricant. Spirit provides one application with this unit. See your Spirit dealer for additional purchases. The use of some other lubricants may destroy the deck surface or belt and will void warranty. Conditions exist beyond Spirit's control on belt / deck cleanliness which relates to friction.

You should apply the enclosed belt lubrication after approximately the first 50 hours of operation. Use all the contents of one container (no more) and spread lubricant onto middle portion (away from edges) of the deck (under treadbelt) along its **width**. When walked on, the belt will make certain an even coat is applied. Lubricant is not harmful to the skin. Lube will be distributed properly by walking at 2 to 3 mph for 3 to 5 minutes on all areas of the belt. Use handrails for support. The first few minutes you will be polishing your deck and lubricating the belt backing. **Do not run on a newly lubricated belt until the above break-in procedure is done.** If the treadmill belt/deck is kept reasonably clean it is possible to expect over 1000 hours before additional re-lubing is necessary.

CAUTION - KEEP HANDS CLEAR OF MOVING REAR PULLEY!

Service Checklist - Diagnosis Guide

Before contacting your dealer for aid, please review the following information. It may save you both time and expense. This list includes common problems that may not be covered under the treadmill's warranty.

PROBLEM	SOLUTION/CAUSE
Display does not light	Tether cord not in position. Circuit breaker on front grill tripped. Push circuit breaker in until it locks. Plug is disconnected. Make sure plug is firmly pushed into AC household wall outlet. Household circuit breaker may be tripped. Treadmill defect. Contact your Spirit dealer.
Treadbelt does not stay centered Treadmill belt hesitates when walked/run on	A user may be walking while favoring or putting more weight on either the left or right foot. If this walking pattern is natural, track the belt slightly off-center to the side opposite from the belt movement. See General Maintenance section on Treadbelt Tension. Adjust as necessary.
Motor is not responsive / Display is lit	Make certain clock is running.
Treadmill will only achieve approximately 7 mph but shows higher speed on display	This indicates motor should be receiving power to operate. Low AC voltage to treadmill. Do not use an extension cord. If an extension cord is required it should be as short as possible and heavy duty 16 gauge minimum. Low household voltage. Contact an electrician or your Spirit dealer. A minimum of 110 volt AC current is required.
Treadbelt stops quickly/suddenly when tether cord is pulled	High belt/deck friction. See General Maintenance section on lubrication.
Treadmill trips on board 15amp circuit	High belt/deck friction. See General Maintenance
Computer shuts off when console is touched (on a cold day)while walking/running	Treadmill is not grounded. Static electricity is "crashing" the computer. Refer to Grounding Instructions on page 4.

Manufacturer's Limited Warranty

Effective October 15, 2004 TREADMILL WARRANTY

Spirit Manufacturing Inc. warrants all its treadmills' parts for a period of 5 years from the date of retail sale, as determined by sale receipt, or eighteen (18) months from the original factory shipping date, whichever comes first. Spirit's responsibilities include providing new or remanufactured parts, at Spirit's option, and technical support to our independent dealers and servicing organizations. In the absence of a dealer or service organization, these warranties will be administered by Spirit directly to a consumer. An extended warranty period applies to the following components:

Drive Motor	30 Years
Deck Wear	5 Years
Electronics / Belt / Rollers	5 Years
Frame Weldments	Lifetime
All Other Components	5 Years

NORMAL RESPONSIBILITIES OF THE CONSUMER

This warranty applies only to products in ordinary household use, and the consumer is responsible for the items listed below:

1. The warranty registration card must be completed and returned to the address listed on the card within 10 days of the original purchase to validate the manufacturer's limited warranty.
2. Proper use of the treadmill in accordance with the instructions provided in this manual, including belt tracking.
3. Proper installation by an authorized Spirit service company in accordance with instructions provided with the treadmill and with all local electric codes.
4. Proper connection to a grounded power supply of sufficient voltage, replacement of blown fuses, repair of loose connections or defects in house wiring.
5. Expenses for making the treadmill accessible for servicing, including any item that was not part of the treadmill at the time it was shipped from the factory.
6. Damages to the treadmill finish during shipping, installation or following installation.

EXCLUSIONS

This warranty does not cover the following:

1. CONSEQUENTIAL, COLLATERAL, OR INCIDENTAL DAMAGES SUCH AS PROPERTY DAMAGE AND INCIDENTAL EXPENSES RESULTING FROM ANY BREACH OF THIS WRITTEN OR ANY IMPLIED WARRANTY.

Note: Some states do not allow the exclusion or limitation of incidental or consequential damages, so this limitation or exclusion may not apply to you.

2. Service call reimbursement to the consumer. Service call reimbursement to the dealer that does not involve malfunction or defects in workmanship or material, for units that are beyond the warranty period, for units that are beyond the service call reimbursement period, for treadmills not requiring component replacement, or treadmills not in ordinary household use.
3. Damages caused by services performed by persons other than authorized Spirit service companies; use of parts other than original Spirit parts; or external causes such as alterations, modifications, abuse, misuse, accident, improper maintenance, inadequate power supply, or acts of God.
4. Products with original serial numbers that have been removed or altered.
5. Products that have been sold, transferred, bartered, or given to a third party.
6. Products that do not have a warranty registration card on file at Spirit Mfg. Spirit reserves the right to request proof of purchase if no warranty record exists for the product.
7. THIS WARRANTY IS EXPRESSLY IN LIEU OF ALL OTHER WARRANTIES EXPRESSED OR IMPLIED, INCLUDING THE WARRANTIES OF MERCHANTABILITY AND/OR FITNESS FOR A PARTICULAR PURPOSE.

SERVICE

Keep your bill of sale. Twelve (12) months from the date on the bill of sale or eighteen (18) months from the date of factory shipping as determined by the serial number establishes the warranty period should service be required. If service is performed, it is in your best interest to obtain and keep all receipts. This written warranty gives you specific legal rights. You may also have other rights that vary from state to state. Service under this warranty must be obtained by following these steps, in order:

1. Contact your selling authorized Spirit dealer. OR
2. Contact your local authorized Spirit service organization.
3. If there is a question as to where to obtain service, contact our service department at (870) 935-1107.
4. If no local service is available, Spirit will repair or replace the parts, at Spirit's option, within the warranty period at no charge for parts. All transportation costs, both to our factory and upon return to the owner, are the responsibility of the owner. The owner is responsible for adequate packaging upon return to Spirit. Spirit is not responsible for damages in shipping. Make all freight damage claims with the appropriate freight carrier. DO NOT SHIP ANY UNIT TO OUR FACTORY WITHOUT A RETURN AUTHORIZATION NUMBER. All units arriving without a return authorization number will be refused.
5. For any further information, or to contact our service department by mail, send your correspondence to:

Spirit Manufacturing, Inc.
P.O. Box 2037
Jonesboro, AR 72402-2037

Product features or specifications as described or illustrated are subject to change without notice. All warranties are made by Spirit Manufacturing, Inc. This warranty applies only in the 50 states of the U.S.A. and Canada.